

High-Tech Creativity



Presented by Jeff Leisner, PhD to Sheboygan North High School

Friday, January 9, 2026

NASA
Astronaut,
Col. Jeff
Williams,
PhD

(

- Older Adults
- People living with disabilities and various disabling conditions
- People recovering from injury and surgery
- People who are sedentary



Earth
1-G

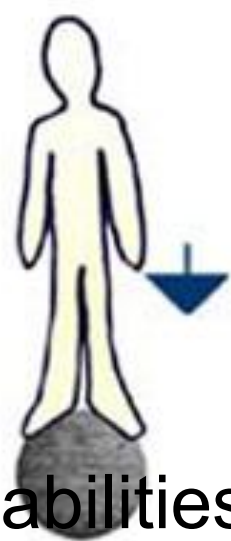

Moon
1/6-G

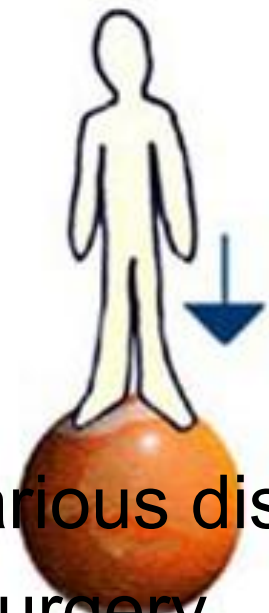

Mars
3/8-G



Space
0-G



STRENGTH AND MOBILITY

Qui:

• Are
Whc

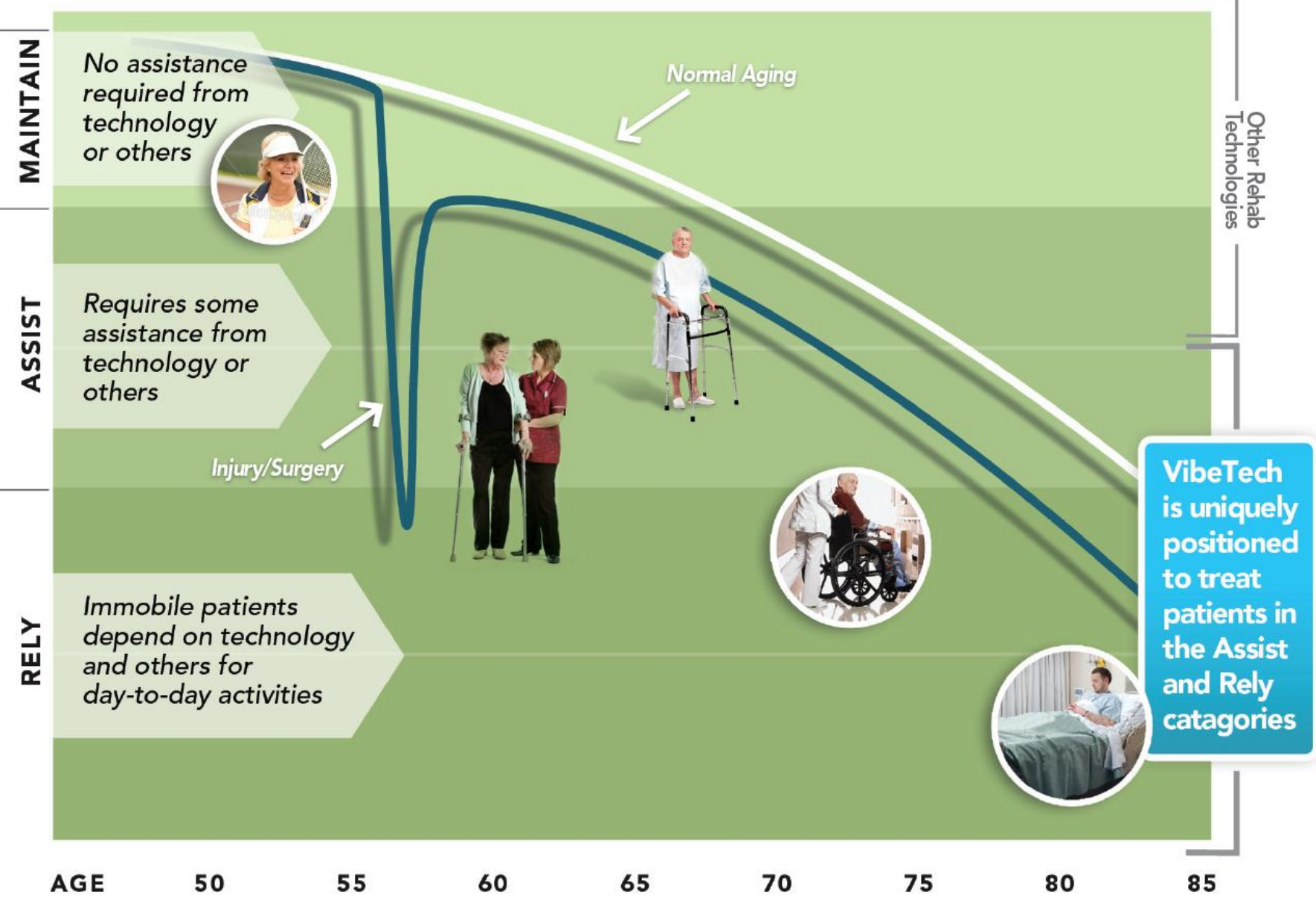

Why?

VibeTech is uniquely positioned to treat patients in the Assist and Rely categories

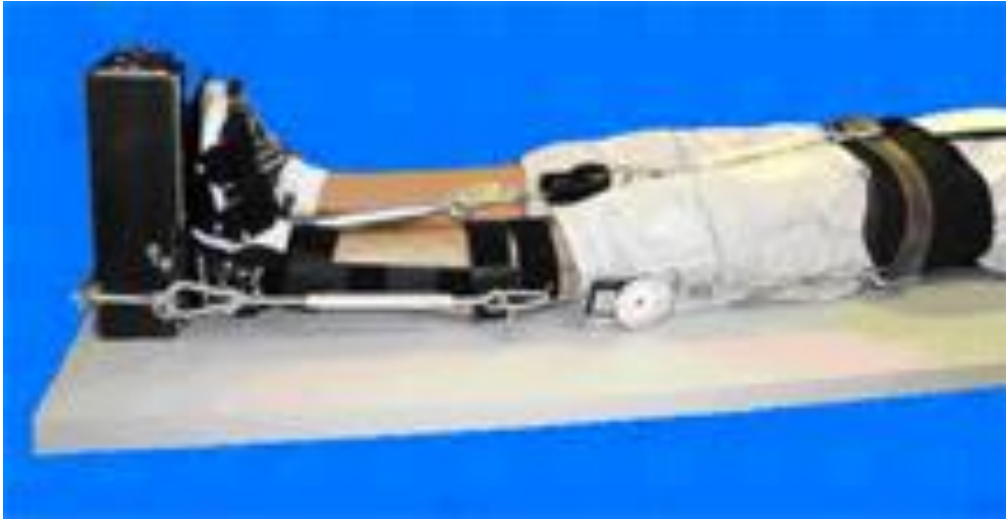

Gravity Independent Vibration Therapy System



US007662115B2

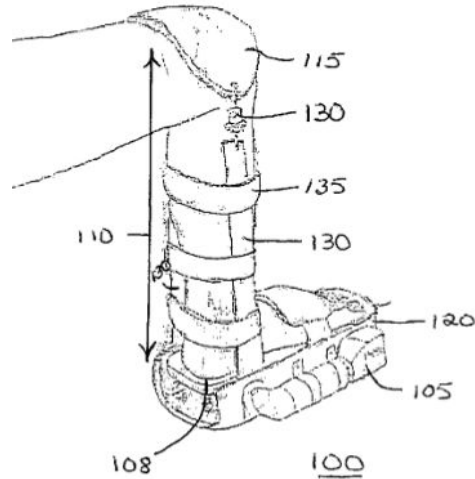

(12) **United States Patent**
Leismer

(10) **Patent No.:** **US 7,662,115 B2**

(45) **Date of Patent:** **Feb. 16, 2010**

(54) **MUSCULOSKELETAL LOADING DEVICE**

(76) Inventor: **Jeffrey M. Leismer**, 999 SW. 16th Ave.,
#98, Gainesville, FL (US) 32601

(*) Notice: Subject to any disclaimer, the term of this
patent is extended or adjusted under 35
U.S.C. 154(b) by 0 days.

(21) Appl. No.: **11/433,988**

(22) Filed: **May 15, 2006**

5,052,378 A *	10/1991	Chitwood	606/242
5,098,040 A *	3/1992	Retat	244/171.9
5,451,202 A *	9/1995	Miller et al.	602/36
5,484,388 A	1/1996	Bassett et al.	

(Continued)

FOREIGN PATENT DOCUMENTS

EP 0482988 4/1992

(Continued)

OTHER PUBLICATIONS

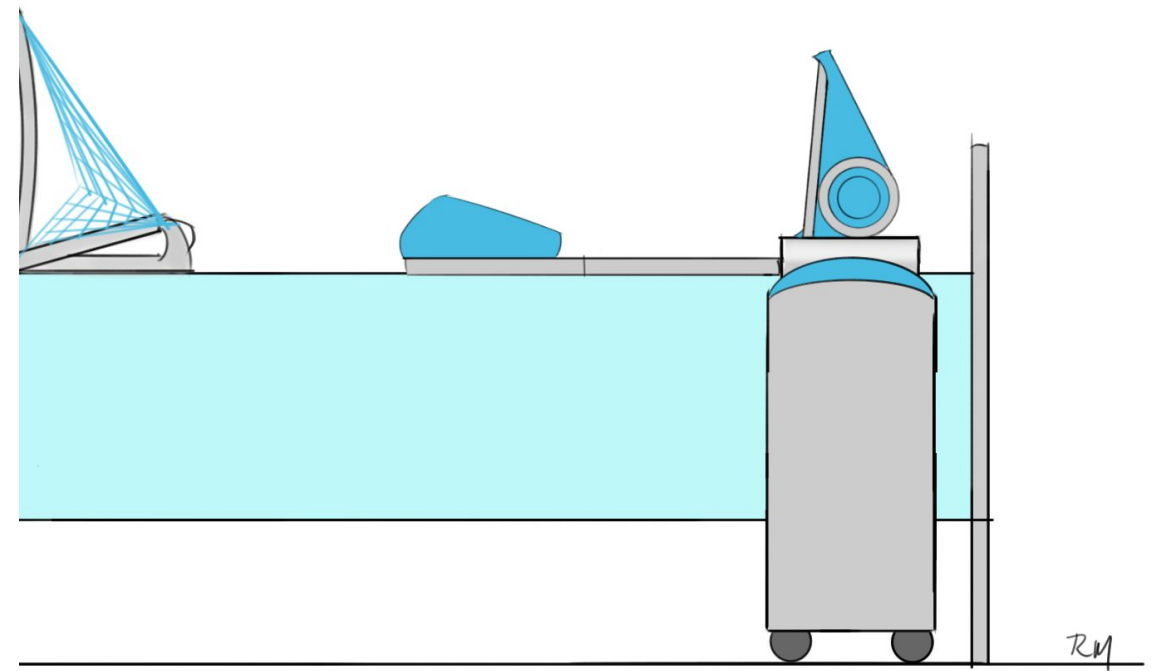
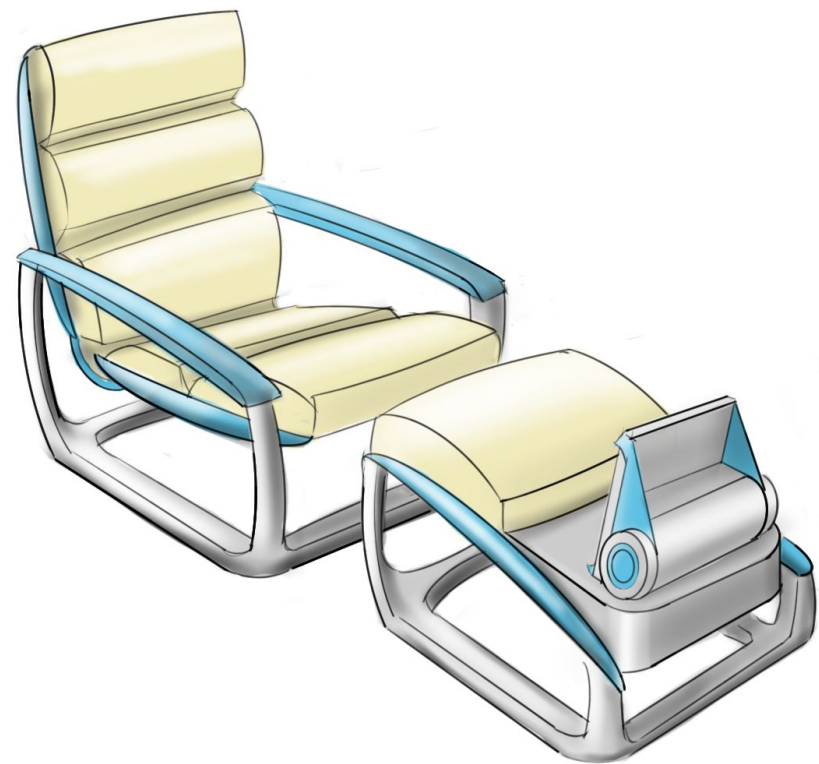
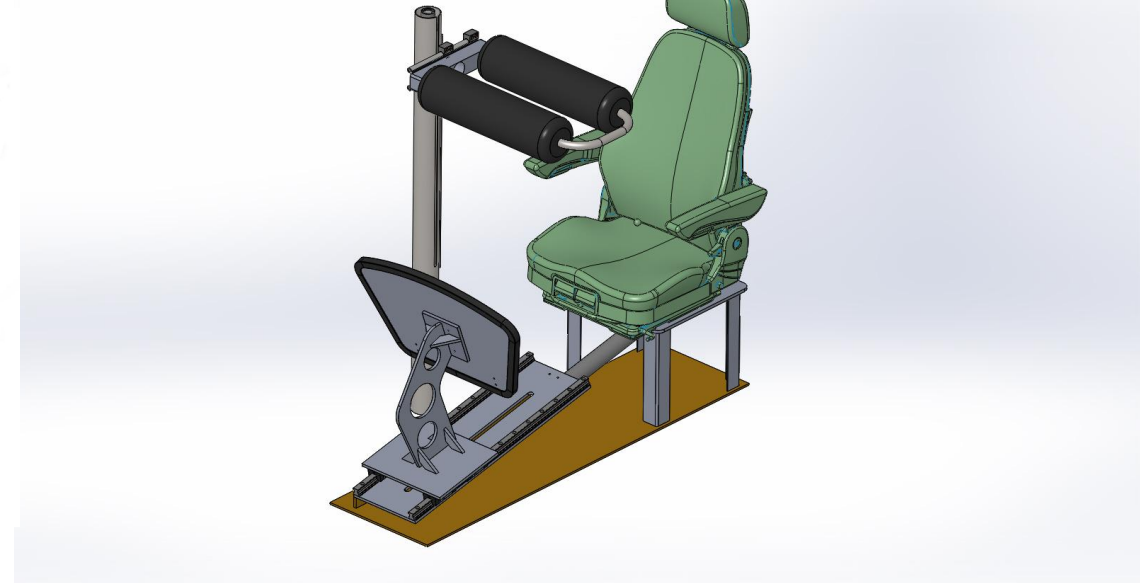
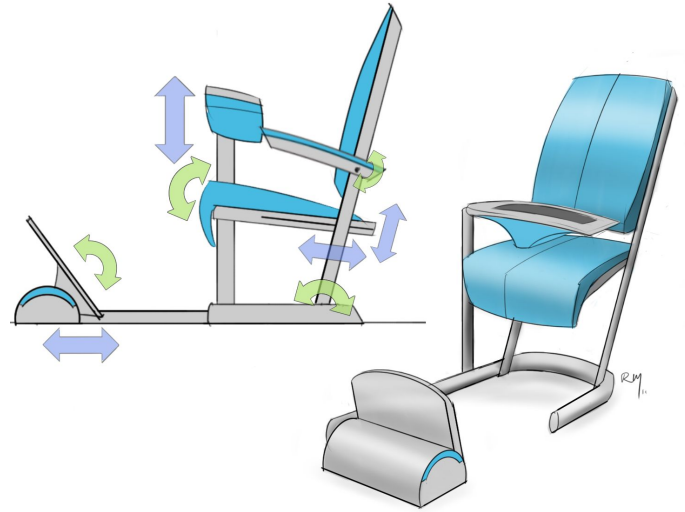
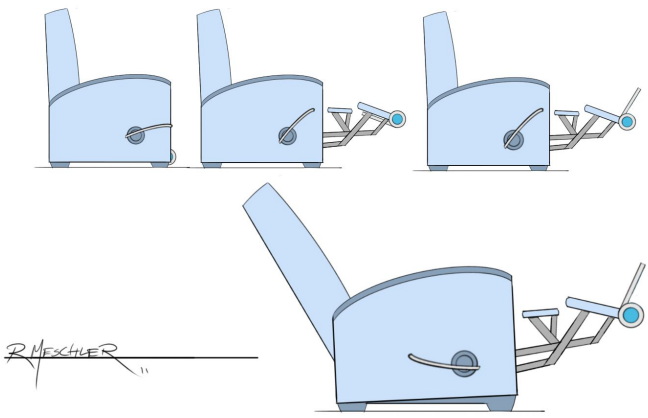

Adapting Designs to be More Accommodating

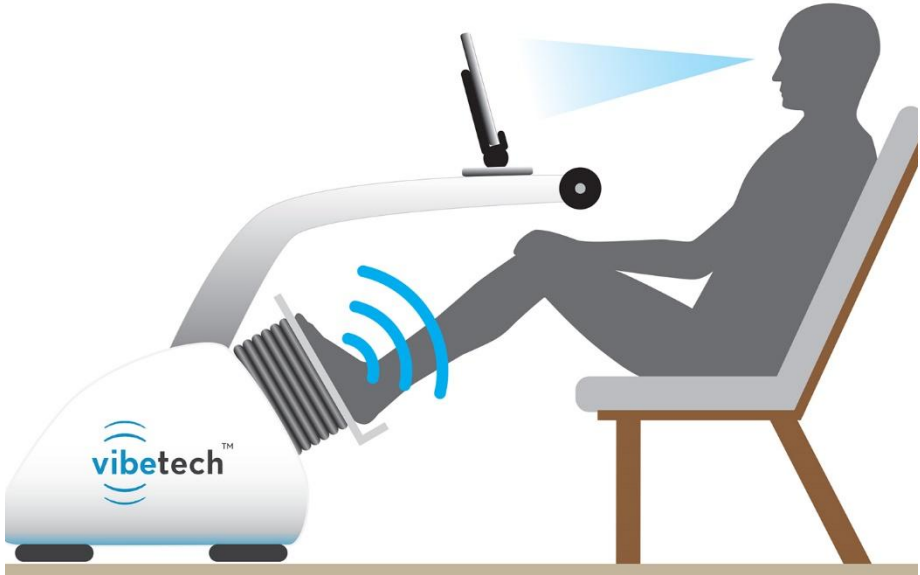
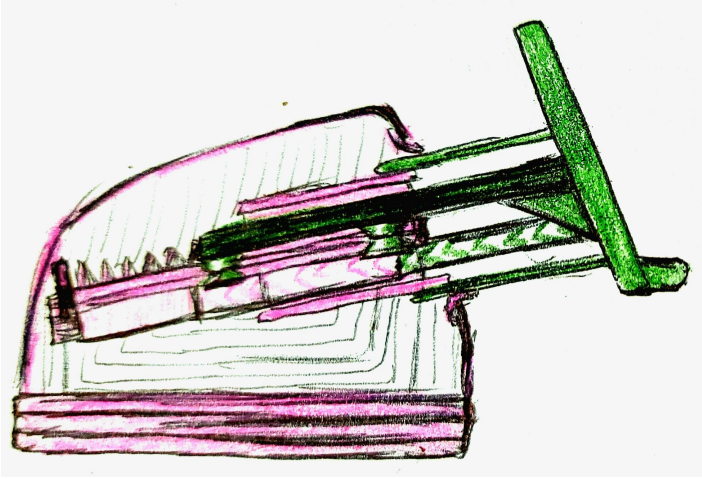
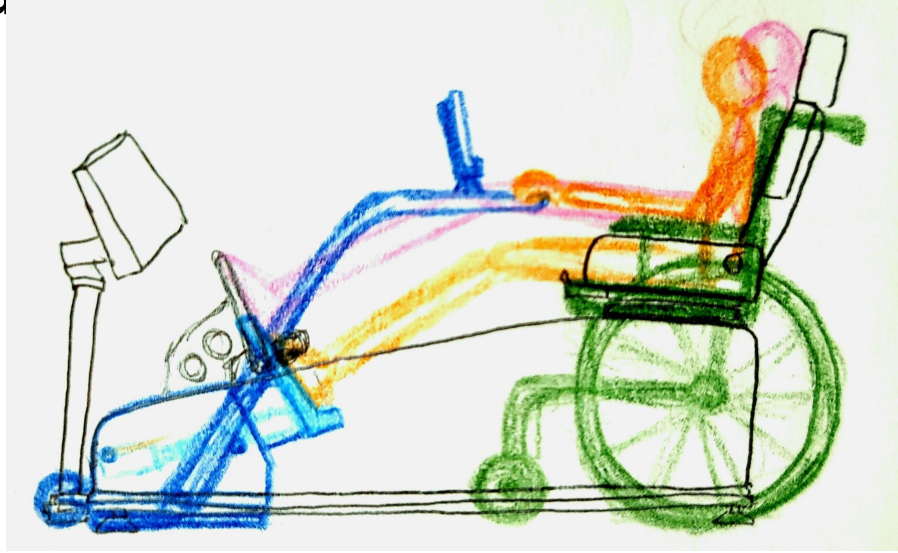

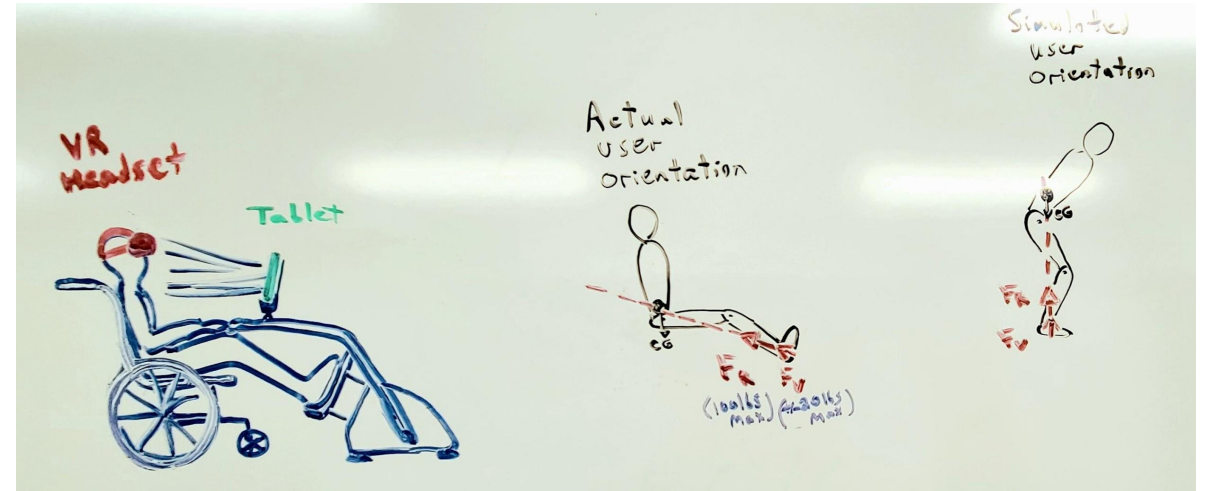

Digital Creativity



Practice Using Creative Skills



Weekly Drawings

Observe, understand,
interpretive depiction



Design Projects

Kickoff is key to inserting
creativity



Document and Protect

The patent process



Inspiring Creativity

- Quiet your mind
- Observe with all your senses
- Critique the objects of your observations
- Do more